



中山市川狼五金制品厂

ZHONG SHAN CHUAN LANG LIGHTING CO., LTD

型号: 单头200W模组-800W

外观图

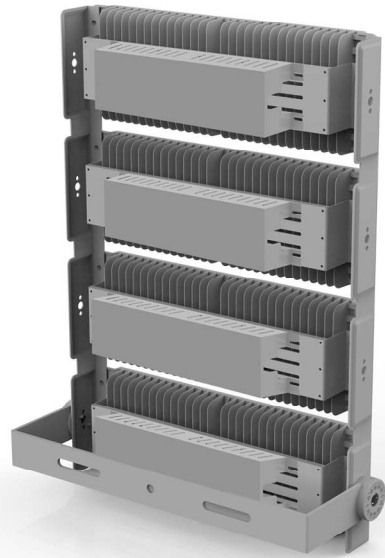
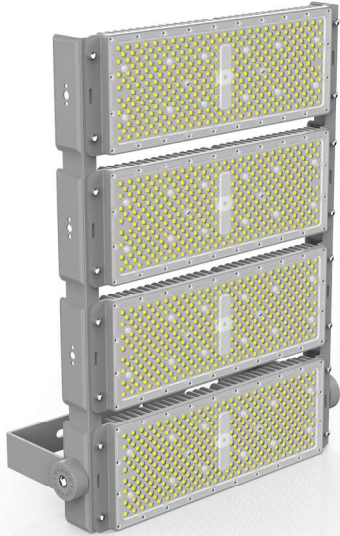

线条图

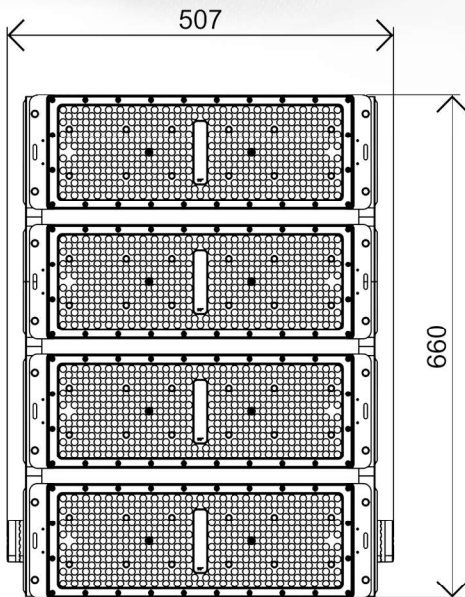

主视图

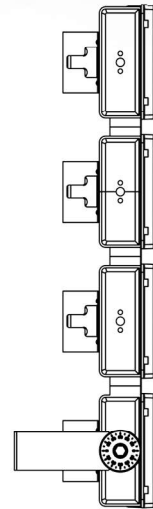

左视图

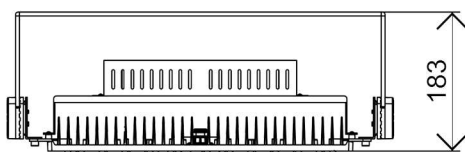

俯视图

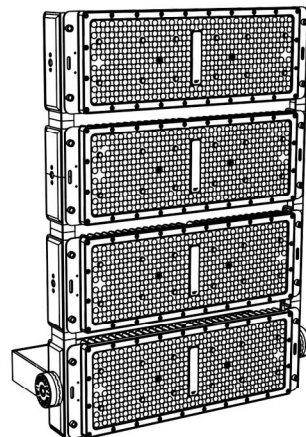

透视图

外形尺寸: W507*L660*H183

铝基板-透镜

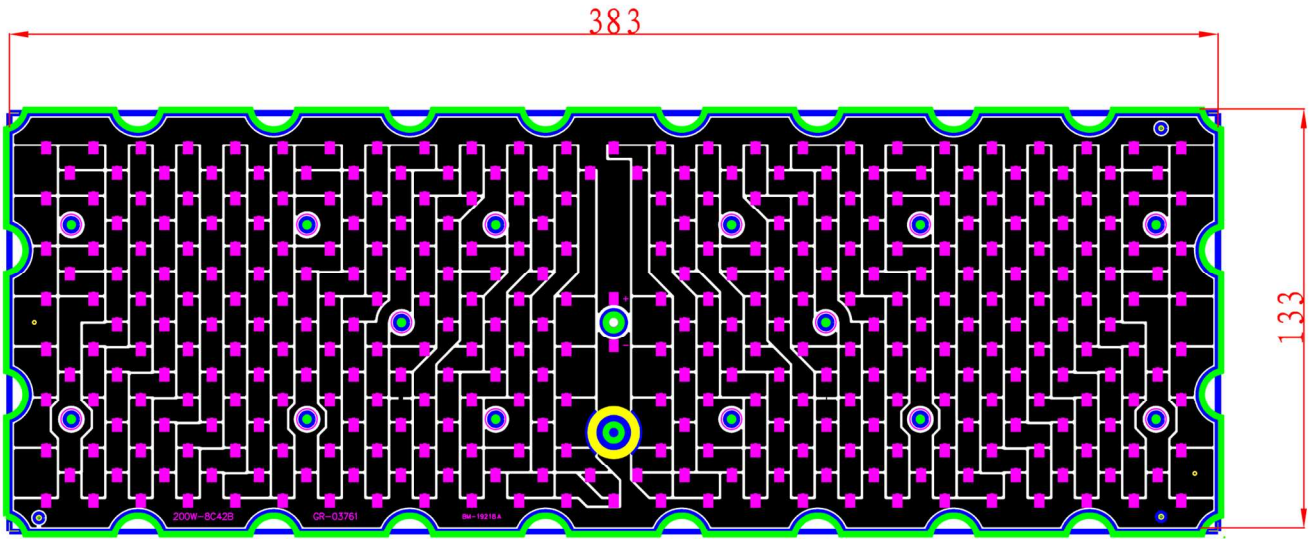

铝基板:尺寸W183mm*L133mm*T实厚1.28mm 42B8C-3030LED-200W

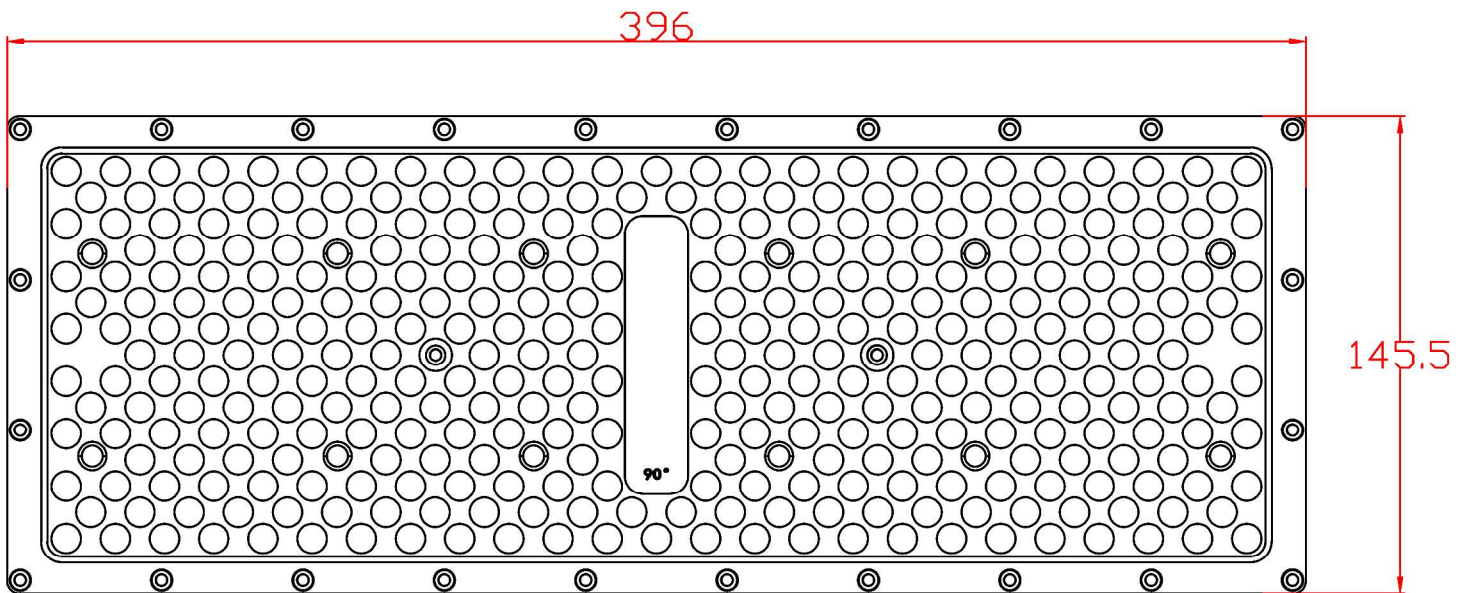

透镜:尺寸W396mm*L145.5mm*H5.2mm

透镜多角度选择: 30度-60度-90度

尺寸孔位

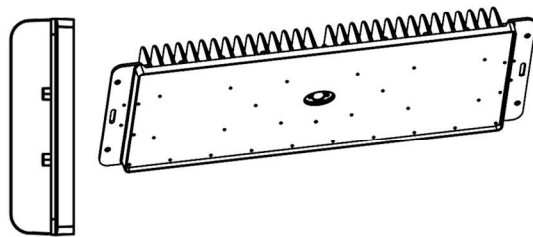
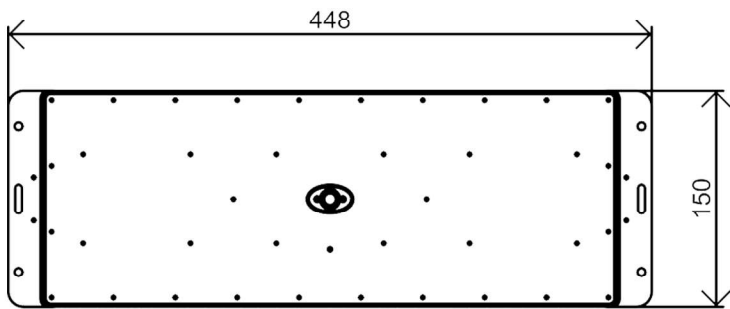
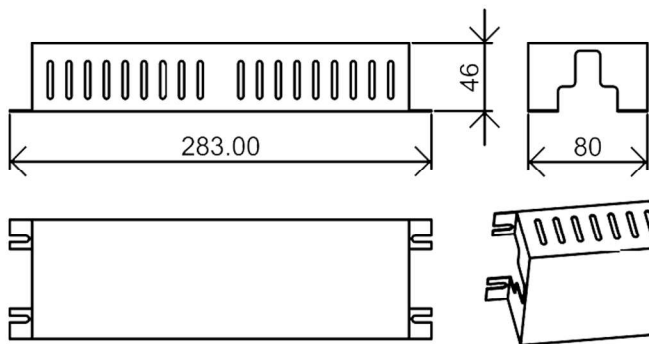

铝合金灯体重量1.66KG

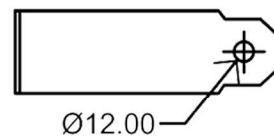
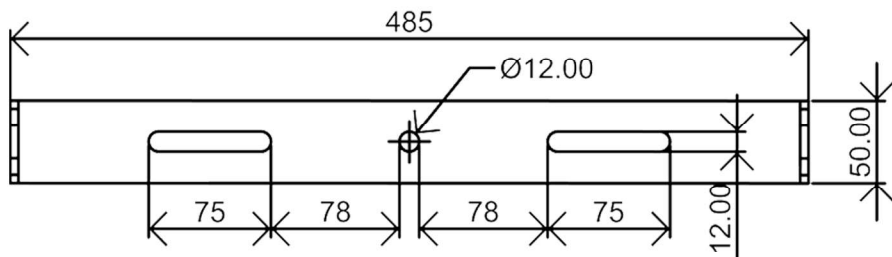
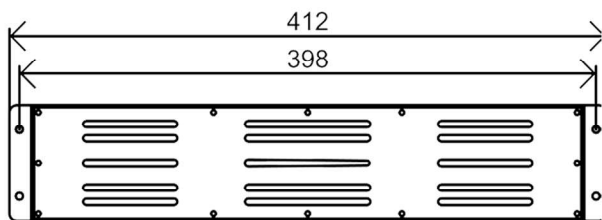
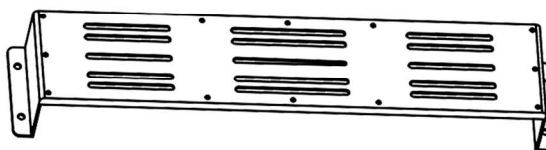
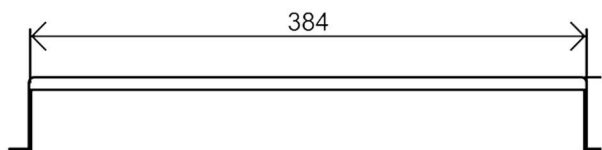

爆炸图

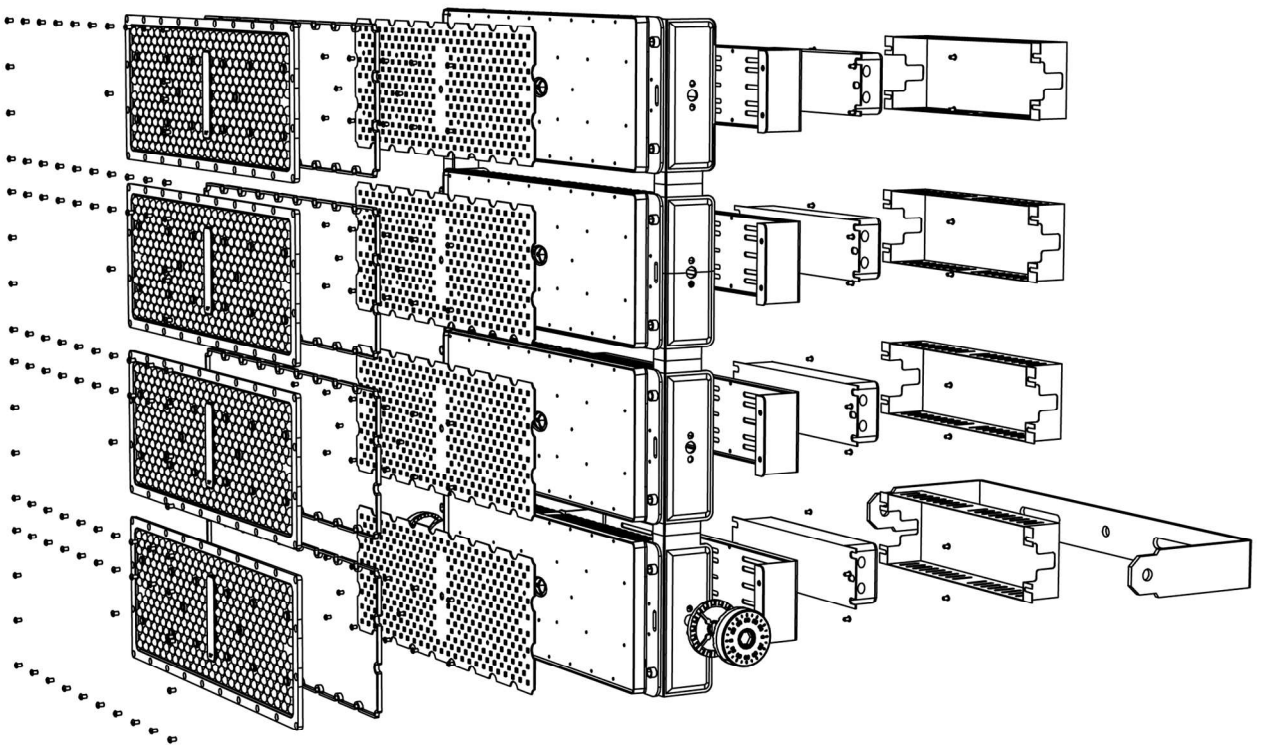
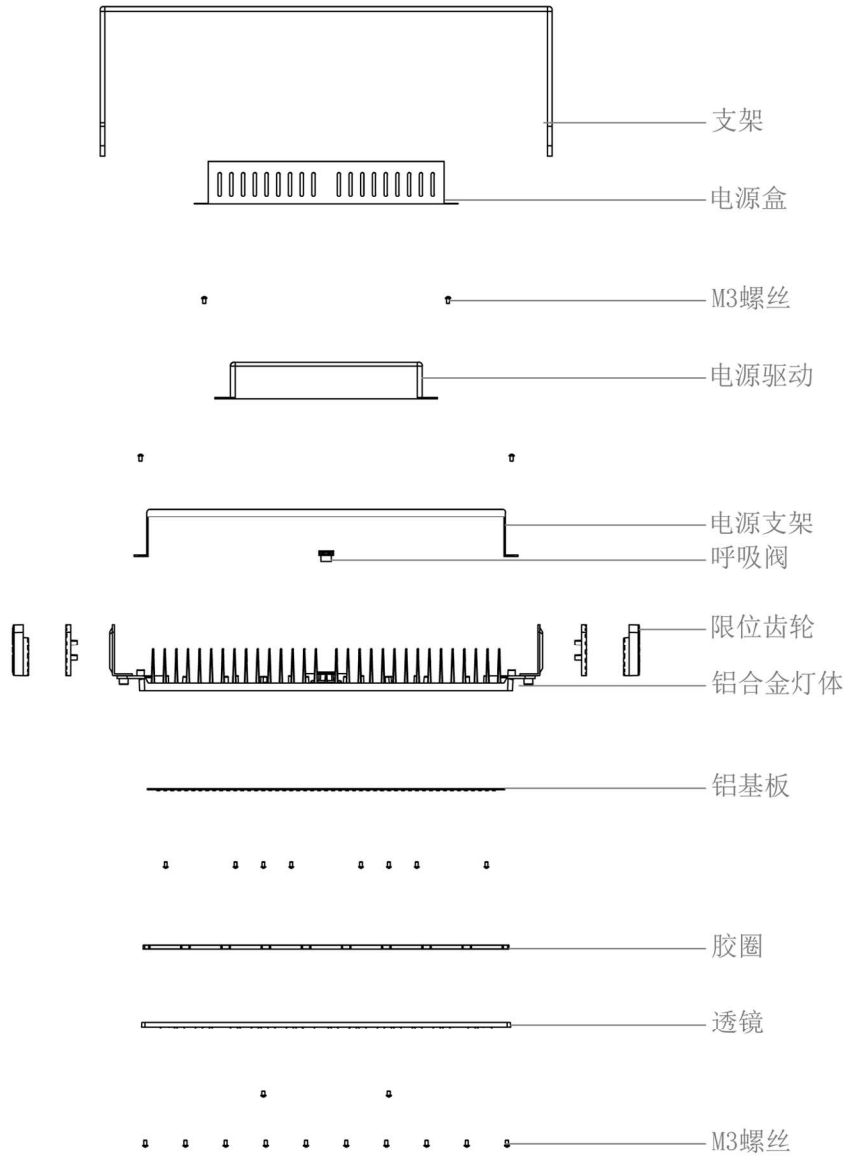

包装尺寸

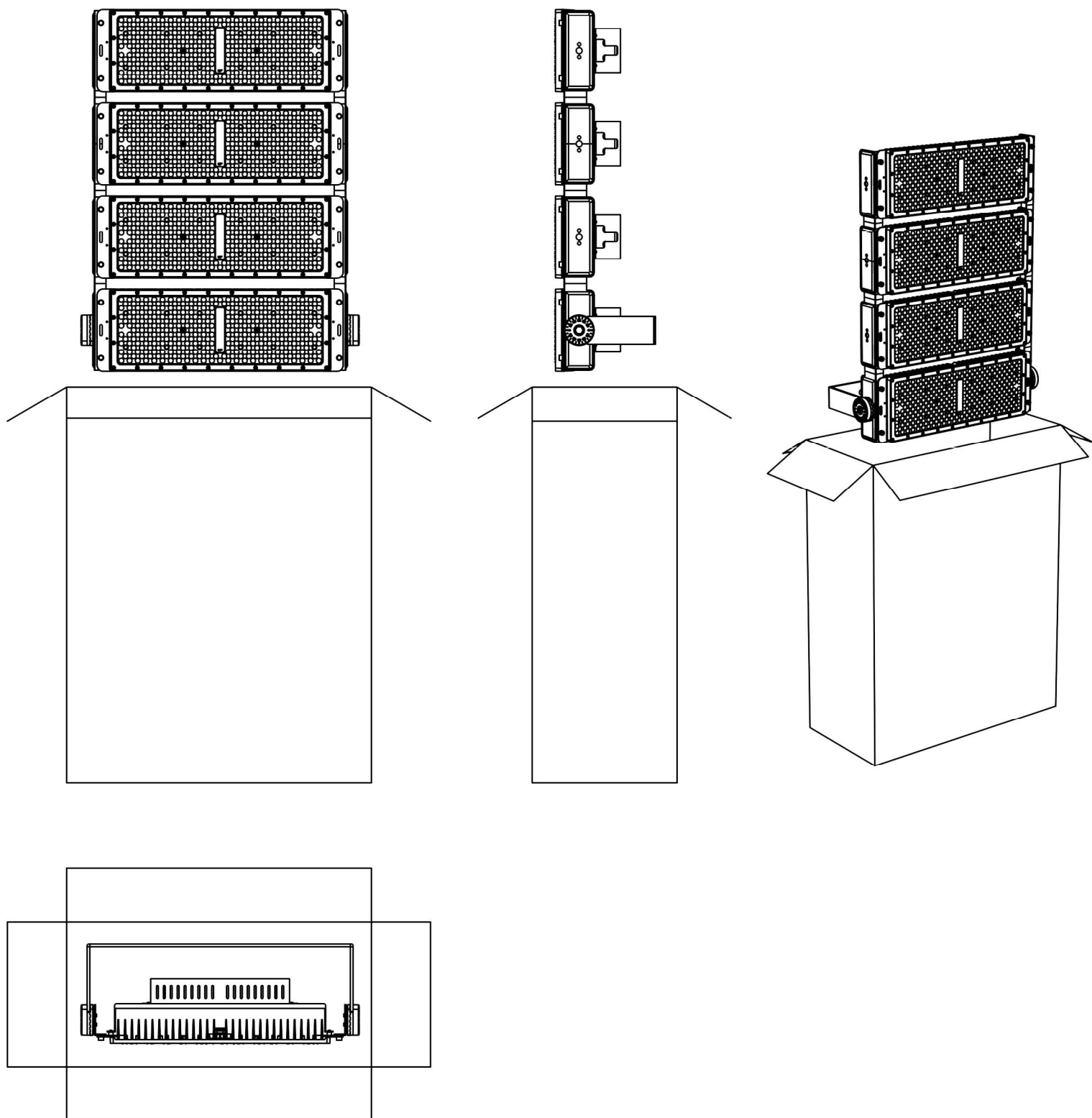

外箱尺寸：505mm*745mm*105mm